

# INTEROPERABILITY IN PRACTICE: GEOMETRIC DATA EXCHANGE USING THE IFC STANDARD

SUBMITTED: July 2007

REVISED: March 2008

PUBLISHED: June 2008

EDITOR: B-C Björk

*Tomaž Pazlar, Researcher*

*Faculty of Civil and Geodetic Engineering, University of Ljubljana, Slovenia*

*email: tomaz.pazlar@fgg.uni-lj.si*

*Žiga Turk, Professor*

*Faculty of Civil and Geodetic Engineering, University of Ljubljana, Slovenia*

*email: ziga.turk@fgg.uni-lj.si*

**SUMMARY:** *The exchange of information between the different organisations and individuals involved in the different stages of a building's life cycle has always been an important, but at the same time a difficult task. A vast number of participants with different views of the same physical structure have to interact and exchange information through the whole building life cycle. In order to find remedies to the current problems, in particular in CAD data exchange, the product modelling and information exchange standards community have developed several high level representations of buildings (known as Building Information Models - BIMs) in order to enable a more coherent exchange of data. Recently the Industry Foundation Classes (IFC), with a considerable number of software implementations, have emerged as the leading solution candidate. But soon after the first implementations doubts have been raised whether claimed IFC specification compliance by a software product insures a sufficient level of interoperability in practical data exchange. In the presented research work the interoperability performance of three widely used IFC compatible architectural design applications has been evaluated. Tests with file based geometry exchange confirmed our anticipations that the IFC interfaces did not work as expected. The tests demonstrated through illustrative (simple and complex) examples revealed several cases of information distortion and/or information loss both on the entity and attribute level. Unsatisfying model handling proved to be characteristic of all the tested exchange scenarios. Our conclusion is that in the future more effort should be put into the IFC interface development.*

**KEYWORDS:** *Building Information Model - BIM, Industry Foundation Classes - IFC, interoperability, architectural design applications, software testing.*

## 1. INTRODUCTION

Science and technology history reveal several communication milestones with their meaningful influence on what is today known as a “built environment”. The importance of information model revolution can be compared with writing, paper & print, digital and electronic revolution milestones (Turk, 2001). Contrary to the line based information exchange (e.g. DXF, IGES, DWG, OpenDWG) where the correct interpretation of data was clearly professionals’ domain, the structured information exchange allows “preservation of meaning” within different design tools.

Currently there is no widely used Building Information Model (BIM) in the Architecture, Engineering, Construction and Facility Management sector (AEC-FM). The absence of BIM is usually ascribed to sector fragmentation and to its unique products. There were several BIM standardization attempts in the AEC branch, but their success can not be compared with similar attempts in related industries - automotive, shipbuilding (Tolman, 1999). The Industry Foundation Classes (IFC) as one of the latest BIM related specifications with considerable number of implementations indicates that circumstances might change in near future. The IFC specification, developed by International Alliance for Interoperability (IAI), started from the vision that the STEP methodology based integrated product model would cover all vital information about the building in its life cycle. IAI made some important steps towards interoperability, but after ten years of development and several IFC specification releases, the exchange and sharing of building and construction lifecycle information has not been completely defined and standardized. Although the latest IFC specification release with more than

600 classes covers a substantial part of required information, the model – just like other complex models – will probably never be completed. General obstacles in completing the model and consequently establishing more effective integrated design and construction processes are well known: 1.) The extent of fragmented AEC-FM branch is much more comprehensive than the extent of related industries. 2. Unique products. 3.) Arranged BIM level of details is not always suitable for all participants. 4.) Attachment to traditional working methods. 5.) Growing branch requirements. Although the discussion about possible solutions is out of this paper scope, some simple solutions will emerge in near future (like using reference data libraries to ensure appropriate level of details).

The IFC building model defined by IAI Model Support Group (IAI-MSG) is based on a structuralized approach where standard specification is publicly available before software implementations (although software vendors may also be involved in the specification development). Such approach with mandatory certification procedure is commonly used when complex models are standardized. (STEP specification for example). However, structuralized standardization approach is not commonly used in rapidly developing information and communication technologies. Several reports criticize its inability of implementing, testing and improving the standard before being publicly released. An immediate feedback on how well proposed standard meets the objectives, presents the key deficiency of structuralized standardization approach (Berhman, 2002). The cited author emphasizes the importance of immediate software vendors involvement in standard development and favours the minimalist approach aims with direct software vendors collaboration. Although the minimalist approach proved to be successful for the internet and some programming language standardization purposes, the structuralized approach is as a rule used in complex models standardization. Although many of Brehman arguments are valid, the appropriateness of minimalist approach in the complex model standardization has never been proven (Kiviniemi et al, 2005).

IAI organizes workshops to certify interface accordance with the IFC specification. Since IFC specification is already too comprehensive, IAI defined “view definitions” which specifies the subset of IFC model (specific list of entities) that has to be supported to enable information exchange in a specific exchange scenario. Currently ongoing IFC 2x3 certification is based on the Extended Coordination View. Certification defined by IAI takes place at public workshops and has two steps: Within the first step application interfaces are tested on simple test cases (spaces, walls, beams, columns, etc.). The second certification step follows after end-users have been using the application for at least 6 months and approved the sufficient quality of import and export IFC interfaces. The application is then tested again using the data from the real projects. The IFC certification logo as the result of successful certification can evidently be misleading. It only states that the application has been certified according to the official IAI facilitated approval procedure for a specific IFC release. Described testing procedure evidently does not ensure full accordance with IFC specification and should be understood only as demonstration of IFC standard implementations: “However, it is still and remains always the responsibility of the implementer to ensure the quality of the IFC interface. Furthermore, it is the responsibility of end users to determine how they use the IFC interface” (IAI-MSG, 2006).

The described IFC certification presents a compromise between the level of exactness and testing expenses and cannot assure full semantic interoperability. The end users therefore cannot blindly trust the mapping process, but have to check the results manually. Despite similar evaluation of IFC interfaces in recent years no specific conclusions related to the latest IFC specification release (and interfaces) could be found in the background literature. Therefore the purpose of our study was to identify and point out possible geometry mapping misinterpretations when exchanging the BIM geometry. Only commonly used IFC compatible architectural design applications have been used in presented research.

This paper is structured as follows: Section 2 introduces a review of related work; Section 3 discusses the interoperability issues (testing domain and procedure); Section 4 presents detailed research results and also discusses the relevant issues that proved to be problematic in the presented IFC file based information exchange. Generalized exchange analysis is discussed in Section 5 and finally, Section 6 consists of conclusions and recommendations for further IFC interface development.

## **2. RELATED WORK**

Information distortion and/or information loss were anticipated due to the complexity of the BIM and due to selected standardization approach. This has been confirmed with the first interface evaluations and pilot project

reports. Inadequate robustness of IFC based conversation process urged for immediate interface quality improvement.

VTT research project SPADEX (Backas, 2001) marked the IFC 1.5.1 release as not suitable for use in the real life projects due to the lack of software specific IFC documentation (like instructions, manuals), loss of information (different ways of handling attributes), distortion of geometry (problems with coordinates mapping), IFC file size (compared with native format), legal liability (user rights), managing and utilizing the data in the model and varying CAD modelling practices (level of exactness).

Probably most known and cited IFC evaluation report is the Stanford PM4D report (Fischer et al, 2002) presenting findings of multidisciplinary effort involved in the use of several IFC 1.5.1 compatible design and planning applications. The HTU 600 (pilot) project described in debated report is not as critical as SPADEX bulletin, but also points out the need for more reliable and more extensible IFC interfaces. Following deficiencies are listed in the report: geometric misrepresentation and unstable performances of IFC compliant middleware and software, confusion in interdisciplinary design revisions, large file size, loss of object information and different requirements of various applications for specific product model representation and organization. The evaluators also recommended ensuring software robustness, partial data exchanges and model server technologies as keys to extending the benefits and improving the reliability of IFC specification. The need to secure privileges, release liability and exact definition of ownership and responsibility of shared information fulfils the wish list.

SPADEX and PM4D report are related to the evaluation of software interoperability in the whole design process. Contrary, FZH Institute in Karlsruhe (Germany) focused their research on discipline based interoperability (Geiger, 2001). Only commonly used IFC 1.5.1 compatible architectural design applications were tested on various building models – from simple constructs to complex structures. This research proved that transformation irregularities can occur inside architectural domain and with certain interfaces even inside specific design application.

The IFC interfaces evaluation closely followed the specification evolution (2.0 and 2x releases). Bazjanac (2002) gathered experiences from several early deployment projects using at that time the latest available IFC release and presented them as “six early lessons”:

- 1) The industry is still unprepared (two dimensional individual design instead of teams of experts),
- 2) Populating the project model with data is not always easy (expectation of upstream / downstream applications),
- 3) Data incompatibility (caused by different procedures for the same operation which results in different interpretation and reformatting),
- 4) Built-in limitations of data model and application (several aspects are not covered in the IFC model yet),
- 5) Project model exchange file size,
- 6) Precaution when choosing software (several interfaces are still in beta status).

The cited author concludes that software interoperability related to the IFC standard (releases 2.0, 2x) is beginning to work in the industry, but not as smoothly and fast as first expected.

A valuable contribution to the IFC interfaces evaluation can be obtained from the IAI German Chapter web site (Buildingsmart, 2006). The available diploma theses apply different approaches and levels of accuracy in the IFC interface testing. Korpowski (2003) investigated standard structure and checked its consistency on simple architectural models. The second thesis (Dayal, 2004) also offers a fundamental overview of the IFC interfaces tested on the architectural design of a manufacturing plant. Both theses still report misinterpretations in the BIM geometry exchange.

Testing the integrity and semantic interoperability seems to be a worldwide absorbing topic. Simultaneously, but unknowingly, a similar research project has been carried out at the University of Auckland, New Zealand. The specially developed application EVASYS (EXPRESS Evaluation System) allows the evaluation of similarities and differences between two IFC models under the EXPRESS schema (Ma et al, 2006). The round trip testing

results indicate that the majority of changes are fairly small and do not affect the semantic of the model. However more significant unexpected changes can also be found (like removal of the tangible objects).

The implementation of complex product model in its entirety is not a trivial process. It usually consists of several model and interface versions, hopefully improved due to the lessons learned from the previous implementation efforts. Almost six years has passed from the publication of IFC 2x Add1 specification and therefore it could be anticipated that the software vendors now provide robust and accurate interfaces that can be reliably used in the actual building project. Although the listed research work and pilot projects indicate interface quality improvement, it is still not clear whether the latest IFC 2x Add1 interface releases ensure a satisfying level of structured data exchange (Pazlar et al, 2006).

### **3. INTEROPERABILITY ISSUES**

#### **3.1 Testing domain**

Several aspects of BIM can be described using the IFC specification and different technologies can be used for achieving interoperability in AEC-FM branch. However, the interoperability term in this paper denotes only file based structured information exchange in the architectural domain. Architecture has been included in the IFC specification from its first release and therefore it can be seen as the most complete and accurate part of IFC based BIM. Although information exchange servers as probably a more convenient way of handling information exchange are already available, most of the current AEC-FM design work is still based on traditional file exchange. Different incompatible releases of IFC specification exist (IFC 1.5.1 (6/1998), IFC 2.0 (6/1999), IFC 2x Add1 (11/2001), IFC 2x2 Add1 (6/2004) and IFC 2x3 (2/2006)). In autumn 2001 published IFC 2x Add1 specification introduces a new platform concept, which presents the framework for insuring upward compatibility. Inside IFC 2x platform entities, attributes, relationships and types should not change. However additional entities, attributes, relationships (belonging to the new entities) and types can be added. The platform concept presents framework for IFC extension.



Presented research began in autumn 2005. This grounds the choice of hopefully mature IFC 2x Add 1 specification and appurtenant interfaces and also explains why the latest IFC specification could not be used. Three most widely used IFC 2x Add1 compatible architectural design applications were used. Applications details can be found in Fig. 1.

#### **3.2 Testing procedure**

IFC specification allows transformation of semantic information between different CAD systems. Although all architectural design tools are optimized for similar purpose, each tool has its own internal representation of semantic artefacts and perfect semantic interoperability therefore cannot be expected (Amor, 2006). Within each IFC interface two schema mappings have to be provided: mapping between internal model and IFC model for export purposes and mapping between IFC model and internal model for import purposes (Ma, 2006). Both mappings are not trivial. They have to be tested separately in order to ensure conformance of individual interfaces. Different qualifiers (IFC file size, number of entities, etc.) can be used in mapping evaluation.

Several models exist in the presented file based information exchange scenario (native origin, exported IFC, native target, re-exported IFC) (Fig. 2). The semantic of native and exported/imported IFC model can differ due to the incomplete mapping. A simple example: material from the origin/target application is not always mapped to the belonging IFC entities. Incomplete mapping between origin/target and IFC specification also has to be taken into consideration when mapping "exotic" or uncommon artefacts. However, the stated information distortion or/and information loss are not the subject of the presented research.

Generally two non visual comparison approaches can apply when analyzing IFC models: direct text and/or object comparison. The direct text comparison between two IFC files is not appropriate due to different ways of populating the IFC based BIM (like diverse sequence of entities in IFC file, etc). Therefore only the object based comparison can be credible.

			
Company	Autodesk	Nemetschek	Graphisoft
Software	Architectural Desktop 2005	AllPlan Architecture 2005	ArchiCAD 9
Abbreviation	ADT	ALL	ARC
Native format	dwg	ndw*	pln
IFC compatibility	IFC2x Add1(Inopso interface)	IFC2x Add1	IFC2x Add1
IFC interface release	2.0.4.8	/	45041
Approx. number of reg. users	500.000**	160.000**	100.000**
Compatibility	Windows 2000, XP	Win XP, Linux SUSE, Novell	Windows XP, Macintosh
Min. processor, RAM, HDD	P4, 1.7 GHz, 1024 MB, 1.3GB	P3, 1.4 GHz, 256 MB, 1GB	P4, 512MB, 1GB
Price (Slovenia, tax included)	5600 EUR***	4500 EUR	3935 EUR

\* Allplan has its own data management system, ndw format presents alternative.

\*\* [Dayal, 2004]

\*\*\* Inopso IFC interface not included, registered price 425EUR (tax not included).

FIG. 1: Software used.

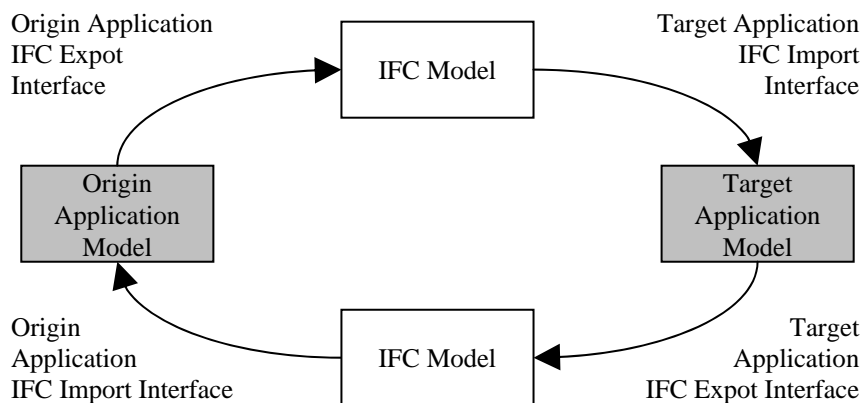

FIG. 2: File based information exchange.

Previously described IAI certification approval procedure presents the combination of visual and syntactic testing. Within the first certification step models originated in the selected design application are exported and then imported into the same and into the other tested IFC applications. Such approach evidently offers evaluation of export (import) interface only if confirmatory software is proven to be fully IFC compatible. If not, the IFC model has to be regularly imported (exported) into a large number of applications in order to achieve the sufficient probability of regular mapping. As most of end-user important entities in the “Extended Geometric View” present physical constructs with clear geometric representation (walls, doors, beams), visual checking can also be used at least for the brief mapping evaluation.

Certification approval procedure therefore evaluates conformance of the whole exchange process and not just conformance of single IFC interfaces. Since certification approval imitates the real project work it is also

appropriate and acceptable for testing procedure in presented research. An additional examination of STEP physical files with object based comparison has also been performed. This should clarify some additional points of interest that can be easily overlooked if only visual checking is used.

Applications and their interfaces were tested with various sets of simple (wall, wall with openings, etc.) and complex test cases (architectural models of residential and business buildings). In the simple model testing building elements were drawn separately in each application and then exchanged with the same and residue application without any modification (Fig. 3). Additional round trip tests with minor model modifications have also been performed in order to clarify certain mapping distortions. Presented workflow has been used only in simple model testing.

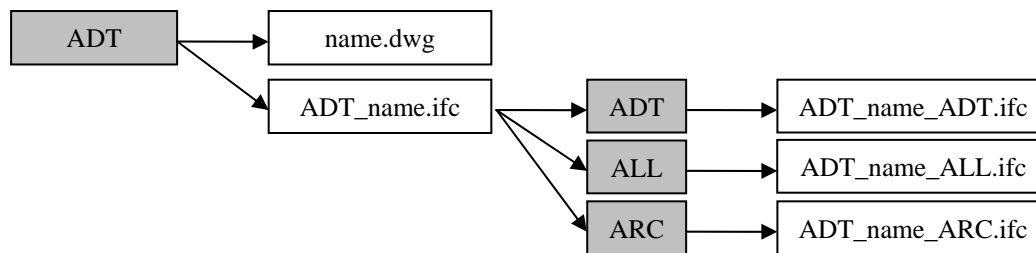

FIG. 3: Testing procedure with ADT as prime application.

Based on the entity and attribute analysis, the object based comparison between two IFC files can be automated comparing the entities by their Globally Unique ID (GUID) (Ma, 2006). However, this analysis cannot be completely valid since some of the non-physical object types do not have GUID, and as presented in the next chapters, some application interfaces unreasonably change the GUID. Therefore it has been decided that – at least in the first stage of the presented research – IFC files will be analyzed and compared manually. Various IFC related freeware has been used in presented analysis: IFCEngineBasic (TNO, 2006), IFCQuickBrowser (GEM, 2006), IFCObjectCounter (FZH, 2006) and visualization tools (IFC Engine Viewer (TNO, 2006), IFCViewer (FZH, 2006), DDSIFCViewer (DDS, 2006).

## 4. INTEROPERABILITY IN PRACTICE – TEST CASES

### 4.1 Wall

Models simple as possible were used in the first stage of presented research. Mapping regularity was first tested on a straight concrete wall originated in the World Coordinate System (WCS) origin point. Although visual control reveals no faults, the differences in the IFC file size indicate mapping irregularities (Table 1).

Round trip testing where single IFC compatible application has been used is characterized as pure round trip testing procedure. Since information distortion or/and information loss have been expected, it is natural to begin evaluation with such tests. The complete accordance of two IFC files has been proven only within Archicad and Allplan: header dataset is excluded and GUID discordance is omitted (see chapter 4.5). The ADT interface in the re-export process replaces the solid representation of wall (IfcExtrudedAreaSolid) with six surfaces bounded by loops (IfcFace) (Table 1). Consequently, IfcWallStandardCase (with “SweptSolid” as the only possible body representation) is replaced with more general IfcWall entity (“SweptSolid”, “Clipping”, “Brep”, “SurfaceMode” and “BoundingBox” as possible body representation). Within architectural design applications such replacements may not be relevant, but may cause difficulties when mapping the model into other AEC-FM applications.

Table 1: Simple wall – file size and entity comparison.

Application	ADT(N)	ADT*	ARC	ALL	ALL(N)	ALL*	ARC	ADT	ARC(N)	ARC*	ADT	ALL
Native file size (bytes)	118980				49174				508688			
IFC file size (bytes)	3756	5080	5044	3198	3253	3253	5598	5218	5631	5635	7113	3577
Difference in file size (%)	-	35.3	34.3	-14.9	-	0	72.1	60.4	-	0.0	26.3	-36.5
Entities – total**	69	98	84	53	53	53	84	98	84	84	127	60
Entities - diverse***	35	37	36	35	35	35	36	37	36	36	38	36
Entities with GUID****	8	12	12	11	8	8	12	12	12	12	18	10
IfcDirection((0,0,1))	5	3	1	3	3	3	1	3	1	1	4	4
IfcShapeRepresentation	Bound- ingBox	Bound- ingBox	Bound- ingBox				Bound- ingBox	Bound- ingBox	Bound- ingBox	Bound- ingBox	Bound- ingBox	
	Curve2D	Curve2D	Curve2D	Curve2D	Curve2D	Curve2D	Curve2D	Curve2D	Curve2D	Curve2D	Curve2D	Curve2D
	Solid	Brep - Face	Solid	Solid	Solid	Solid	Solid	Brep - Face	Solid	Solid	Brep - Face	Solid
Entities required*****	13	33	13	10	10	10	13	33	13	13	33	10

\* Export and import into origin application.

\*\* Entities – total. The number of all instances in specific IFC file represented by writing the name of the entity in capital letters and then followed by the attribute values in predefined order. Example - see Fig. 6: "#208=DOORPANELPROPERTIES(...)"

\*\*\* Entities – diverse. Number of different entities needed for specific BIM description.

\*\*\*\* Entities with GUID. According to the IFC specification a unique reference number denoted as Globally Unique Identifier (GUID) can be assigned only to the leaf node objects (Example – see Fig. 6: IfcWall, IfcDoorPanelProperties, etc).

\*\*\*\*\* Entities required for specific geometric representation context e.g. for geometric description of the wall: 1.) As an extruded solid. 2.) As a collection of surfaces bounded by loops.

One of the main IFC model objectives is to provide exchange and sharing of information between different (homogeneous and heterogeneous) software applications. The occurrence of mapping irregularities is again expected and clearly indicated with the differences in IFC file sizes (-36.5% to 72.1%) (Table 1). Although the number of diverse entities in each IFC file (Table 1, row 5) does not differ much (35-38) detailed analysis exposes different BIM modelling approaches. Although all three applications in the first export process use solids as the geometric representation of the wall, the attribute presenting the swept area of IfcExtrudedAreaSolid differs. Semantically, the IfcArbitraryClosedProfileDef and IfcRectangularProfileDef entities present the same surface to be extruded but syntactically based checking would report discordance. Solids as geometric representation of BIM are also preserved in almost all re-export processes. ADT again presents exception where solids are replaced with the surface boundary representation model. Different approaches in geometry modelling can also be observed within the other geometric representation contexts. When the wall is circumscribed as an axis (IfcLine), IfcTrimmedCurve (ADT, ALL) or IfcPolyline (ADT) is used. Although all description approaches used are compliant with the IFC schema, the record length significantly differs. Ten (or thirteen) entities are required when a solid is used for the geometric representation of wall. But when the surfaces are used, the number of entities increases more than three times (to 33). The presented issue has relevant influence on record length which presents one of the major obstacles in the IFC implementation.

The number of property objects with a single numeric or descriptive value assigned also differs. Allplan interface generates only four IfcPropertySingleValue entities which describe the layer and the corresponding components of RGB colour schema. The entity structure of the layer record is preserved within the mapping, but RGB attributes change their values. Archicad additionally populates the IFC model with property objects which additionally elucidate geometric representation of the wall.

The noticeable imperfection of Allplan IFC interface is not proper IfcBoundingBox record handling. Allplan interface does not generate this entity when exporting or re-exporting the model. No particular geometric representation (IfcShapeRepresentation) based on bounding box primitives is therefore possible.

The various uses of IfcBuildingStorey entity indicate a diverse IFC specification interpretation. Only the Archicad interface generates this entity when exporting the native model or re-exporting the imported IFC model (entity is generated even if has been omitted in the imported BIM). However, if the IfcBuildingStorey entity is present in the imported IFC model, then it is always preserved when re-exporting the model. According to the

IFC specification relations between IfcProject, IfcSite, IfcBuilding and IfcBuildingStorey have to be defined as IfcRelContainedInSpatialStructure (BuildingStoreyContainer for Building Elements) or as IfcRelAggregates (all other relationships). However, tested interfaces are not compliant with IFC specification: the IfcSite entity is omitted by all interfaces. Within the origin model export only the Archicad interface generates the IfcBuildingStorey entity and the belonging relationship.

Entities originated in the IFC kernel layer (IfcProject, IfcWall, etc.) contain two descriptive attributes: Name (can be used by participating software systems or users) and Description (exchanging informative comments). It may seem that stated attributes preserve their values only in the roundtrip testing procedure where single application is used. However detailed analysis revealed that values in the export process have not been preserved but simply rewritten with the same ones. This is partly proved with all other tests where Name and Description attributes do not preserve their value. Further analysis showed similar non-preservation whenever IfcLabel and IfcText entities are used as descriptive attributes (as ContextIdentifiers, ContextType, etc).

The accuracy of model is one of the key aspects in product modelling. The IFC model accuracy is defined as a tolerance under which two given points are still assumed to be identical. The tolerance can be prescribed to each geometric representation context separately. The tested IFC standard implementations use equal accuracy (1E-05) for all IfcGeometricRepresentationContext entities. Although accuracy has been preserved in all test cases it is not reasonable why ADT alternates the exactly defined coordinates: (0, -12.5, 270) to (0.0001, -12.5, 270).

All cited IFC evaluation reports (Chapter 2) emphasize the IFC file size as one of the key implementation obstacles. Although the significance of the problem is noticeable primarily with complex BIMs, simple models may be more appropriate to conceive some possible record optimization methods. The suggested optimization refers to the re-use of entities. The IfcDirection entity in global Z axis for example needlessly repeats itself up to five times (Table 1). None of the tested applications seem to pay any attention to the record optimization issues since various reiterated entities are present in each analysed file. The stated imperfection cannot be marked as a mapping misinterpretation but more likely as a noteworthy possible interface improvement.

## 4.2 Wall with opening(s)

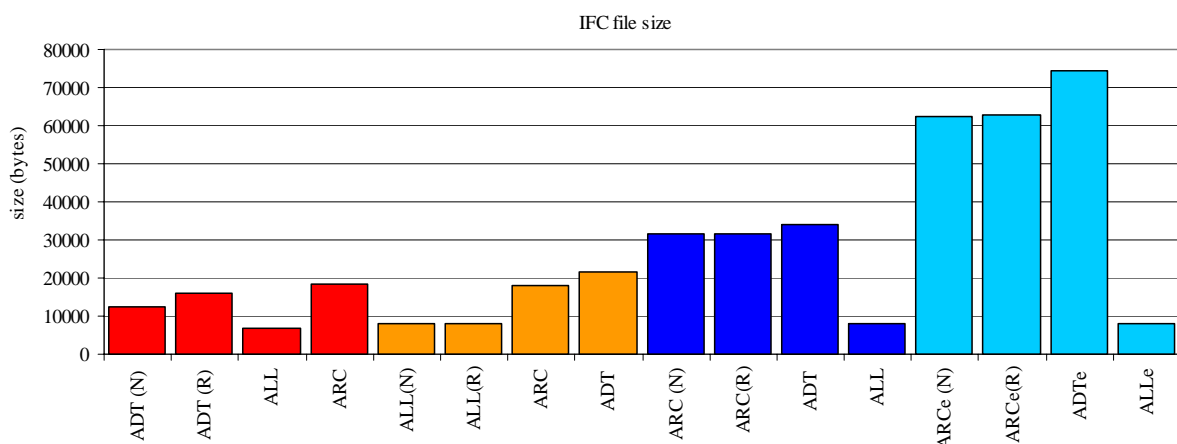

FIG. 4: IFC file size – wall with door and window.

Wall models from previous chapter were populated with additional artefacts (doors, windows) and corresponding IFC files were analyzed.

Although representing the same BIMs, the difference in file size indicates different modelling approaches (Fig. 4). Archicad IFC interface again generates the most comprehensive IFC files (ratios: ARC/ALL 4, ARC/ADT 2.55, ADT/ALL 1.95).

Archicad interface as the only interface offers the export of “Extended Properties” (such models are denoted with letter “e”: ARCe, ADTe, etc). Term “Extended properties” mark additional properties of BIM primitives which cannot be described with the existing IFC entities and corresponding attributes. IfcPropertySet as a dynamic extension of IFC model has to be used instead (note that the number of different entities in Archicad based models (ARCe(N) and ARCe(R)) do not differ – Fig. 5). IfcPropertySingleValue presents the elementary



entity for BIM extension. As attributes these entities are assembled in IfcComplexProperty and further into IfcPropertySet (entity with GUID). Extending the attainment of model may seem as a valuable contribution to the BIM, but such model population is not always welcome (Fig 4). The physical file size for example increases for more than 100%. The extended model may seem semantically richer, but analysis revealed many undefined attributes (fire rating of door panel, heat transfer coefficient, facility management inventory number, etc). Re-export in Archicad does not affect the preservation of extended properties. A similar conclusion holds true if ADT is used as the re-export application. ADT interface has also some additional exemplary characteristic – like preservation of IfcComplexProperties dependency to the origin application (through the PropertyDependsOn attribute). Furthermore ADT interface preserve the Archicad based IfcPropertySet entities. Although some additional characteristics are added and consequently the number of IfcPropertySets differs, three complex property sets inherited from Archicad (Graphisoft AC90 WALL, Graphisoft AC90 DOOR, Graphisoft AC90 WINDOW) exemplary preserve all their origin attributes.

When mapping the model with the extended properties, the Allplan interface proved to be the worst choice. Not a single extended property is preserved in the export process.

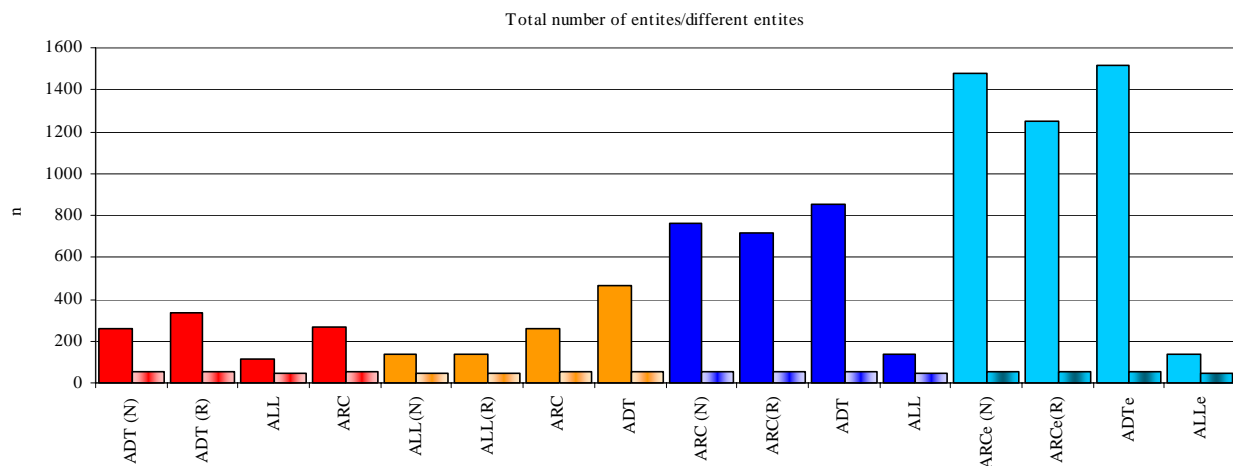

FIG. 5: Wall with openings. Total number of entities (all instances in specific IFC file) / number of different entities used for specific BIM description.

The number of diverse entities required for supplemented BIM description increases when inserting the door and window into the wall. The specific number is interface specific and occupies values from 43 (ALL) to 54 (ADT, ARC). Different geometric description methods are used on different BIM artefacts (wall, door and window): ALL and ARC use solids but the ADT generated geometry is based on surfaces (Table 2). Both geometry modelling approaches are accordant with the IFC specification and if no special requirements are given, the record length presents the only significant difference. Similar as with the wall model, Allplan again omits all BoundingBox representations.

In the IFC specification the BIM artefacts (wall, door, railings, etc.) are defined to the certain level of precision. Although all attributes should preserve their values, the presented tests proved the opposite. Most commonly misinterpreted is the IfcDoorStyle Name attribute – only the ADT interface seems to preserve its value. The door panel properties description assembled in the IfcDoorPanelProperties entity proved to be a problematic part of the record. As presented in Fig. 6 four of nine attributes deviate from the original model values: GUID, panel depth, panel width and panel position which almost ironically changes from the middle (original ARC model) to the left (ALL) and finally to the right (ADT). The re-exported IFC models, originated in Archicad, contain the highest number of door related attribute alterations in all three testing procedures. Similar conclusions are also valid for the IfcWindow entities. The name attribute (if defined) is not preserved within the IfcWindowStyle and IfcWindow entities either. Most of the window related attribute alterations are again noticed in the Allplan originated IFC files. The panel position attribute is lost when re-exporting to ADT. The ironically changed attribute can be found again (OperationType): its value changes from “not defined” (ARC) to “pivorthorizontal” (ALL) and finally to “fixedcasement” (ADT).

Table 2: Wall, door, window - geometric representation.

Application	ADT(N)	ADT*	ARC	ALL	ALL(N)	ALL*	ARC	ADT	ARC(N)	ARC*	ADT	ALL
DOOR	BoundingBox	BoundingBox	BoundingBox				BoundingBox	BoundingBox	BoundingBox	BoundingBox	BoundingBox	
IfcShape-Representation	/**	/	/	/	/	/	/	/	/	/	/	/
	Brep-Face	Brep-Face	Solid	Solid	Solid	Solid		Brep-Face	Solid	Solid	Brep-Face	Solid
WINDOW	BoundingBox	BoundingBox	BoundingBox				BoundingBox	BoundingBox	BoundingBox	BoundingBox	BoundingBox	
IfcShape-Representation	/**	/	/	/	/	/	/	/	/	/	/	/
	Brep-Face	Brep-Face	Solid	Solid	Solid	Solid		Brep-Face	Solid	Solid	Brep-Face	Solid

\* Export and import to origin application.

\*\* Curve representation is not used in door (window) description.

```
ARC_wd.ifc
#208= IFCDOORPANELPROPERTIES ('3Q2hw5ysbAJwIe199WozUv', #13, $, $, 0.04, .SWINGING., $, .MIDDLE., $);
#212= IFCDOORSTYLE ('2_mueMi5H979SZNdlei8V', #13, 'D1', $, $, (#204, #208), $, $, .SINGLE_SWING_RIGHT.,
.NOTDEFINED., .T., .F.);
```

```
ARC_wd_ALL.ifc
#90 = IFCDOORPANELPROPERTIES ('23vigU_9fBPuJ8b3aDbJMH', #5, $, $, 0., .SWINGING., 1., .LEFT., $);
#91 = IFCDOORSTYLE ('0TBvdyzJHDmufWL_hgGg4C', #5, 'default_name', $, $, (#89, #90), $, $,
.SINGLE_SWING_RIGHT., .NOTDEFINED., .T., .F.);
```

```
ARC_wd_ALL.ifc
#150=IFCDOORPANELPROPERTIES ('1eYeB$QK91eR7Jo$PFFYVe', #16, $, $, 40., .SWINGING., 1., .RIGHT., $);
#151=IFCDOORSTYLE ('3CW9pqogb5X9J9ZLcNXeEk', #16, 'D1', $, $, (#149, #150), $, $, .SINGLE_SWING_RIGHT.,
.NOTDEFINED., .T., .F.);
```

FIG. 6: Alteration of door related attributes: *IfcDoorPanelProperties* – GUID, *PanelDepth*, *PanelWidth*, *PanelPosition*, *IfcDoorStyle* – Name.

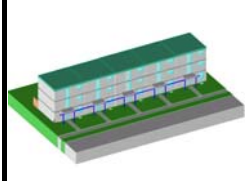
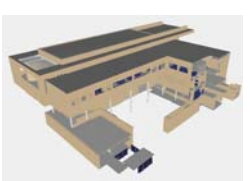

Table 3: Alteration of Window related attributes (GUID attribute is discussed in chapter 4.5).

Entity	Attribute	ADT_wdw.ifc	ADT_wdw_ALL.ifc	ADT_wdw_ARC.ifc
IfcWindowPanelProperties	PanelPosition	.NOTDEFINED.	.NOTDEFINED.	.MIDDLE.
IfcWindowsStyle	Name	Casement	default_name	IFC2x_WindowSingle
		ALL_wdw.ifc	ALL_wdw_ARC.ifc	ALL_wdw_ADT.ifc
IfcWindowStyle	Name	default_name	IFC2x_WindowSingle	IFC2x_WindowSingle
		ARC_wdw.ifc	ARC_wdw_ALL.ifc	ARC_wdw_ADT.ifc
IfcWindow	Name	Wind-068	\$	Wind-068
IfcWindow	OverallHeight / OverallWidth	1., 1.	\$, \$	1000., 1000.
IfcWindowPanelProperties	OperationType	.NOTDEFINED.	.PIVOTHORIZONTAL.	.FIXEDCASEMENT.
IfcWindowPanelProperties	PanelPosition	.MIDDLE.	.MIDDLE.	.NOTDEFINED.
IfcWindowsStyle	Name	W1 Casement	default_name	W1 Casement

### 4.3 Complex models testing

The regularity of geometry transformations presents the main point of interest in the complex model testing. Although some (tangible) end user important entities with clear meaning have already been analyzed within the simple model testing, their global behaviour still has not been evaluated. Therefore, the complex model testing presents unique opportunity to evaluate behaviour of BIM artefacts as parts of real life BIMs.

Table 4: Complex models: Tangible end user important entities analysis.

																
	Smiley West.ifc				AHUS_house.ifc]				NHS_office.ifc				ResidentialHouse.ifc			
Entity/Application	ADT	ADT	ARC	ALL	ADT	ADT	ARC	ALL	ARC	ARC	ADT	ALL	ARC	ARC	ALL	ADT
IfcBuildingStory	5	5	5	5	0	0	0	0	5	5	5	5	6	6	6	6
IfcSpace	70	70	70	70	103	103	102	102	95	95	84	95	14	14	14	14
IfcBeam	1	1	1	1	75	75	166	75	113	113	113	113	0	0	0	0
IfcColumn	10	10	10	10	113	113	113	113	268	268	268	265	13	13	12	13
IfcWall/IfcWallS.C.	135	135	135	135	492	490	492	409	1417	1417	1352	1527	361	361	358	360
IfcSlab	60	60	60	60	109	109	109	120	808	807	715	780	87	87	87	87
IfcDoor	85	85	85	85	69	69	69	42	120	120	120	0	16	16	0	16
IfcDoorLiningProp.	27	27	85	85	48	48	69	5	120	120	118	0	16	16	0	16
IfcDoorPanelProp.	30	30	115	115	59	59	75	6	156	156	154	0	16	16	0	16
IfcDoorStyle	27	27	85	85	48	48	69	42	120	120	118	0	16	16	0	16
IfcWindow	40	40	40	40	49	49	49	0	39	39	39	67	24	24	37	27
IfcWindowLiningPr.	4	4	40	40	23	23	49	0	39	39	28	67	24	24	0	27
IfcWindowPanelPr.	4	4	40	40	23	23	49	0	47	47	28	75	24	24	0	27
IfcWindowStyle	4	4	40	40	23	23	49	0	39	39	28	67	24	24	37	27
IfcRoof	0	0	0	0	11	11	11	0	0	0	0	0	0	0	0	0
IfcStair	15	15	15	15	8	8	8	8	11	9	11	11	0	0	0	0
IfcRailing	20	20	20	20	0	0	0	0	2	2	2	2	0	0	0	0

Origin application.

A slightly different testing approach was used in complex model testing. Several dozen of IFC based BIMs were obtained from different sources. After ascertaining the origin application, the re-export procedure was used to create the IFC models in the origin and in the residue applications. After visual checking, the object based analysis was performed. Due to the inadequate GUID management (see chapter 4.5) the attempts to automate such comparison were omitted. Most representative models were chosen and analyzed with the help of already introduced tools.

Most common end user important tangible entities are presented in Table 4. All listed entities contain GUID attribute and due to the model semantic preservation at least their number should not be changed. All selected entities in all test cases are unique (not duplicated) which has been proven with Solibri IFC Optimizer (Solibri, 2007).

Smiley West IFC model (FZH, 2006) presents exemplary model mapping where all observed entities have been regularly mapped. Visual model checking does not reveal any major faults except the already introduced door and window related mapping irregularities (Chapter 4.2). However, the attribute analysis proves the opposite. If BIM contains more complex artefacts, mapping irregularities become evident. Re-exporting the AHUS model (IAI-NO, 2006) for example reveals major gaps in interpretation of beams (Archicad generated IFC file) and walls (Allplan generated IFC file). Allplan also eliminates one IfcSpace entity, similar as ADT interface. Two concerning mapping irregularities occurred: the number of walls increases (16%) and windows are no longer present in the model (only openings in the walls have been preserved). The last problematic mapping traced in the Allplan generated IFC file is the replacement of IfcRoof artefacts with IfcSlab entities. Pure roundtrip test

has also been performed. It proved some inconsistency within the ADT interface (two walls were not mapped correctly).

Similar mapping irregularities also occur if BIMs are generated with Allplan or Archicad IFC interface. The model incompatibility again occurs in the pure round trip testing: one slab and two stairs have been eliminated (ARC). Results get worse when a different application is used for re-exporting: regardless of the model used (NHS Office, Residential House, etc) the mapping irregularities can be tracked down with almost every entity used, even with the most basic one (IfcColumn). Only the IfcBeam entity seems to be immune to mapping irregularities, but further testing of the Archicad based IFC files proved the opposite. Although the Residential house model contains three staircases and two railings the non standardised description approach is used: the IfcSlab entities are used for description of both artefacts in the original IFC file and understandably also with all other generated files.

The IFC complex models analysis also reveals some general misinterpretations (not interface specific). The number of IfcWindowPanelProperties (IfcDoorPanelProperties) is in some test scenarios larger than the number of IfcWindow (IfcDoor). Since these numbers also surpass the origin numbers of the same entities, misinterpretation is evident. The presented deficiency is not interface specific and can be traced with all interfaces.

Handling the door and window properties seems to be the Allplan interface imperfection. No grounded reason could be found for occasion elimination or fragmented description of discussed artefacts.

Furthermore, the attributes of semantically equal entities should be analyzed. A severe misinterpretation of certain artefacts was detected within geometry related entities and attributes. Misinterpretations occur regardless of the origin application and testing sequence and due to the GUID absence (see chapter 4.5) unique evaluation qualifier cannot be defined. Following attribute irregularities list complements the one already introduced in chapters 4.1 and 4.2):

- Geometry distortion – columns and/or walls are not aligned, slab and roof elements are misplaced.
- Required attachments not present (e.g. opening to wall).
- Element connections not correct (wall connection).
- Misplaced window shutters.
- Changed artefact shape (windows).
- Changed (layer) colour of elements presenting the same artefacts.
- Changed material properties (or not preserved).
- Changed position (layer) colour of furniture elements (or not preserved).
- Changed shape/dimension of ambient artefacts, etc.

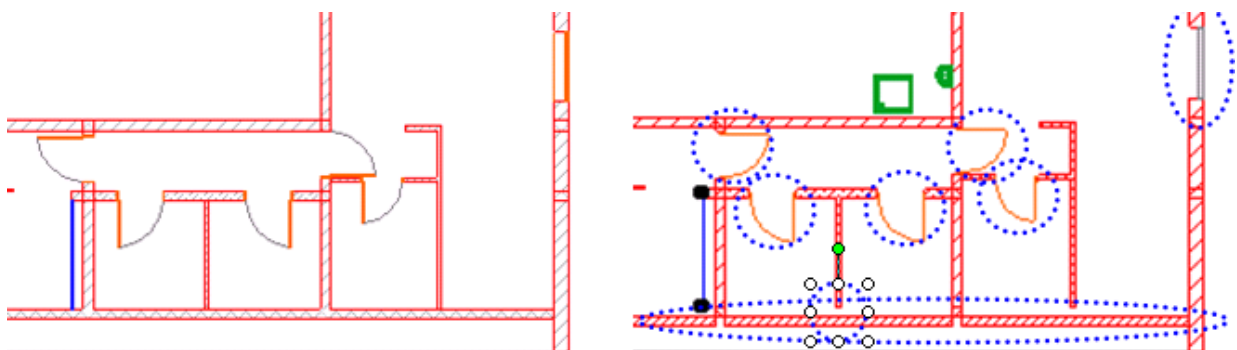

FIG. 7: Mapping irregularities within complex model testing (ARC-ALL).

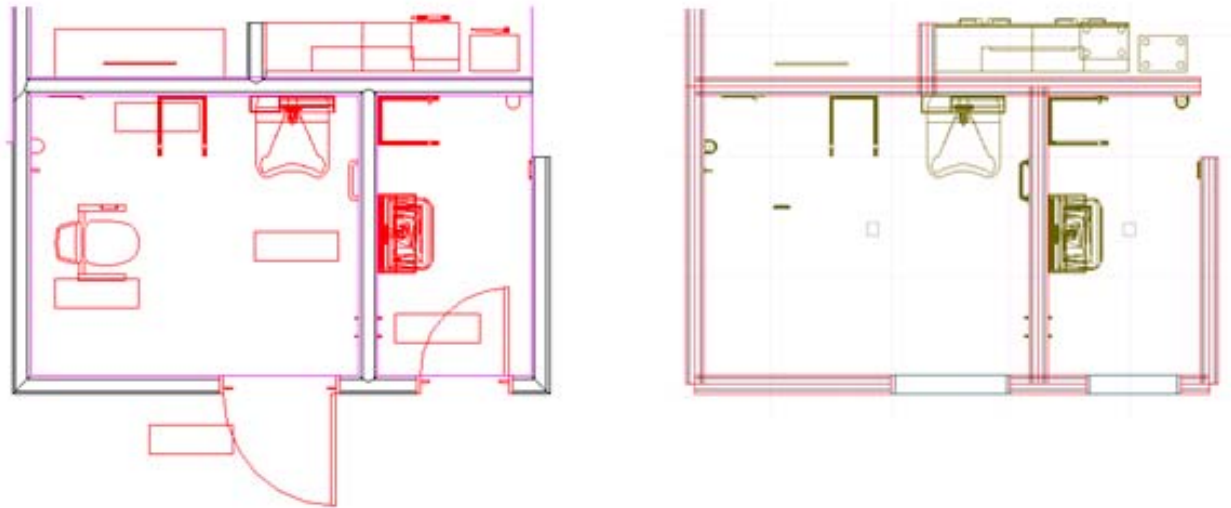

FIG. 8: Mapping irregularities within complex model testing (ADT-ARC).

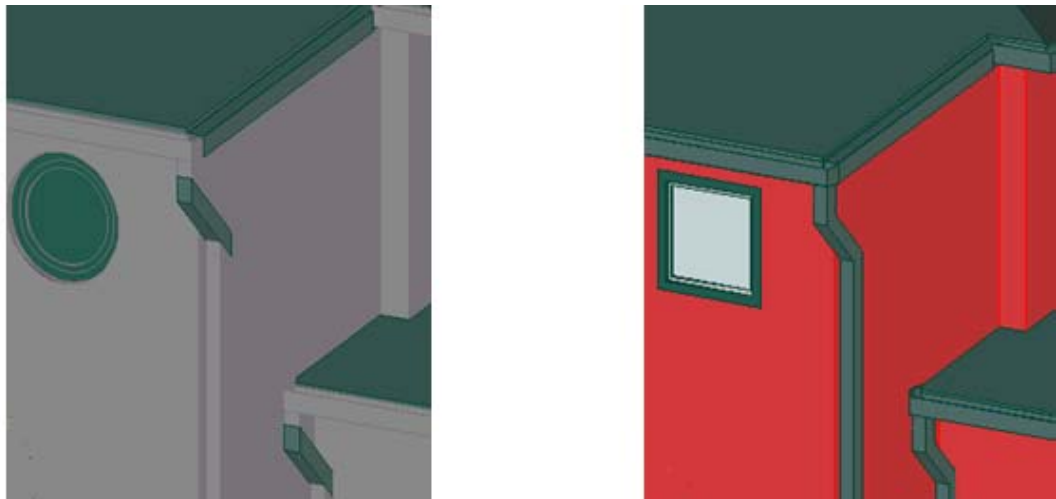

FIG. 9: Mapping irregularities within complex model testing (ARC-ADT).

#### 4.4 Ownership issues

The accessibility and the use of the building data through its whole life cycle present one of the most important BIM issues. The IFC model contains a mechanism to identify the creator and the owner of a specific object and the application for that object, as well as a mechanism to capture the last modifying date, application and user. The iterative AEC design process and various design changes often require not only the identification of the “last modifying application and user”, but also detailed provenance which is unfortunately out of the IFC 2x specification scope.

When re-exporting the model, all tested IFC interfaces transfer user and application ownership from the origin (design) application to the re-exported application. According to the Model Implementation Guide (Liebich, 2004) this is not contestable, but information about the application and the user who created the model (and not just re-exported) are lost. Consequently the fourth *IfcOwnerHistory* attribute defining actions, associated with changes made to the specific object, should also change its value from “added” to “nochange” (since the objects in used testing procedure have not been modified). But as proven with the round trip testing, managing the mandatory *ChangeAction* attribute is simplified: ADT and ALL regardless of the operation performed always use “added” enumeration type (ARC uses “no change”).

The already introduced round trip testing procedure may not be the best case for discussing the provenance data. The testing procedure has therefore been modified: an additional wall has been added to the simple wall model (introduced in chapter 4.1) before re-exporting the model. If the provenance data would be handled correctly then an additional IfcOwnerHistory entity should be added to the IFC record. However, the modified testing procedure proved the opposite: all applications transfer creation to ownership and there was no record about creating each wall in separate application.

Although the IFC specification strongly encourages an optional State attribute use (defining accessibility of object), none of the tested applications defines it. The last modifying date, application and user attributes are also optional and as anticipated none of the tested interfaces implements them. Only the CreationDate attribute is implemented according to the specification. Consequently saving several IFC model versions probably presents the only possible solution to the BIM provenance.

## 4.5 GUID

The ability to identify object uniquely as well as to preserve information about its ownership is fundamental to the IFC model (Liebich, 2004). The IFC model entities can be uniquely identified in the entire life cycle with already introduced fixed length string value named GUID. The presented attribute can be assigned only to the selected important end user entities (leaf node entities). Although GUIDs should remain intact regardless of the file transformations, the test results proved the opposite: Genuine Unique Identifiers do not always preserve their value. As expected and proved, the preservation is rather interface than procedure specific (Table 5). Only the entities with at least one preserved GUID are alleged. However, the IFC record contains many more entities and the percentage of preserved GUIDs is generally low (always below 22%). Evidently there is no preservation of associations between imported IFC entities and corresponding objects inside each application's native database (see the Discussion chapter for details).

The complex model testing confirmed already stated findings regarding the GUID preservation (Table 6). The remaining tested interfaces do not entirely fulfil the IFC specification requests either. GUIDs of the IFC model essential entities (IfcProject, IfcBuilding, IfcBuildingStorey) are preserved only within ARC and ADT interface (only IfcBuildingStorey GUIDs are not preserved when using ADT interface). The Archicad and ADT interfaces are also more comprehensive than the Allplan interface regarding the GUID preservation of other tangible entities (IfcStair, IfcRailing, IfcDoor, etc.). However the re-export in Allplan has also proved some inconsistency regarding the IfcSlab entities (not all GUIDs have been preserved). Non preservation of GUID referring to entities (IfcDoorLiningProperties, IfcDoorPanelProperties, etc) which somehow explain the tangible ones is also the common characteristics of all interfaces. The same conclusions about GUIDs preservation are also valid for the entities describing relationships ("Rel" following the "Ifc" prefix).

The results of the "GUID testing" additionally confirm the already proven deficient entity handling (ADT – IfcBuildingElementProxy, ADT and ALL – IfcPropertySet).

Table 5: Detailed GUID analysis results (wall with door and window, Archicad as origin application).

Application		Entities	Entities with GUID	Entities with preserved GUID	Entities which preserve GUID
<b>ADT</b>	ADT	258/335	28/32	5	IfcProject, IfcBuilding, IfcWallStandardCase/IfcWall, IfcWindow, IfcDoor
	ALL	116	36	1	IfcWallStandardCase
	ARC	264	22	5	IfcProject, IfcBuilding, IfcWallStandardCase, IfcWindow, IfcDoor
<b>ALL</b>	ALL	134/134	30/30	1	IfcWallStandardCase
	ADT	462	36	5	IfcProject, IfcBuilding, IfcWall/, IfcWindow, IfcDoor
	ARC	261	25	6	IfcProject, IfcBuilding, IfcWallStandardCase, IfcWindow, IfcDoor, IfcBuildingStory
<b>ARC</b>	ARC	854/854	36/36	6	IfcProject, IfcBuilding, IfcWallStandardCase, IfcWindow, IfcDoor, IfcBuildingStory
	ADT	1178	42	5	IfcProject, IfcBuilding, IfcWall, IfcWindow, IfcDoor
	ALL	134	30	1	IfcWallStandardCase

Table 6: GUID analysis – Row House. Origin application: Archicad. Entities describing relationships are not presented in the table.

Application	Entity types/total entities	Entities with GUID	IfcProject	IfcBuilding	IfcBuildingStory	IfcSlab	IfcWall/IfcWallStandardCase	IfcBuildingElementProxy	IfcColumn	IfcStair	IfcRailing	IfcOpeningElement	IfcDoor	IfcDoorLiningproperties	IfcDoorPanelProperties	IfcDoorStyle	IfcPropertySet	IfcWindow	IfcWindowLiningProperties	IfcWindowPanelProperties	IfcWindowStyle
ARC	69/ 9182	27	1	1	5	12	27	2	2	3	12	28	17	17	17	17	166	8	8	8	8
ARC	69/ 8722	27	1/1	1/1	5/5	12 /12	27 /27	0/0	2/2	3/3	12 /12	28 /0	17 /17	17 /0	17 /0	17 /0	166 /0	8/8	8/0	8/0	8/0
ADT	68/ 23312	27	1/1	1/1	5/0	12 /12	27 /27	0	2/2	3/3	12 /12	28 /0	17 /17	17 /0	17 /0	17 /0	169 /0	8/8	8/0	8/0	8/0
ALL	67/ 11600	27	1/0	1/0	5/0	12 /11	27 /27	2/2	2/2	3/3	12 /12	28 /0	17 /0	17 /0	17 /0	17 /0	69 /0	8/0	8/0	8/0	8/0

Note: Values in grey present the number of specific entities / number of specific entities that preserve GUID in the mapping process.

## 5. DISCUSSION

The simple models used in the first phase of presented research offer a convenient origin point for the BIM content analysis. The syntactic comparison is not applicable: The object based comparison must apply. The differences perceived in the IFC file comparisons (Fig. 10) simultaneously present all possible entity based differences between two IFC records describing the same BIM. The entity level comparison revealed only a minor number of intact entities (except in the pure ALL and ARC based round trip testing where only the file header data and some GUIDs differ). The replacement of entities is usual practice when different geometry modelling approaches are used. Adding the entities generally enriches the model (IfcPropetySet), but there are also some contrary cases (not defined newly added properties). The entity comparison has also revealed a different level of exactness used when describing the BIM artefacts: some interfaces (ADT, ARC) within the re-exporting process simply add the missing entities which additionally clarify the used artefact. The initialized mandatory and even optional (!) attributes in added entities may satisfy the IFC specification requirements, but the model characteristics clearly do not describe the actual state. The removal of specific entities (primarily noticed with the Allplan interface) can also be problematic and result in information loss.

When analyzing complex models, the comparison should be based on tangible end user important entities containing GUIDs. Their purpose is clearly defined: the unique identification of end user relevant entities (like location, beams, columns, etc) in the building life cycle. Such testing approach has already been used and automated (Ma, 2006). Due to the unreasonable GUID modification, the suggested automated mapping evaluation is simply not feasible with the IFC files generated by tested interfaces. Although clearly defined and indispensable, the GUIDs were not fully taken into consideration by the implementers. The discussed inconsistency (which should be eliminated in the future) clearly originates in the semantic artefacts mapping. The pure geometry object mapping is clearly not enough when the preservation of all GUIDs is required. The most general solution for solving GUID problem would require preservation of associations between the imported IFC entities and objects inside each application's native database. However, difficulties can also occur in the object based comparison: different approaches used in defining the representation attribute of tangible BIM artefacts (solids, surfaces) is just one example where the semantically equal models would not pass the object based equality test.

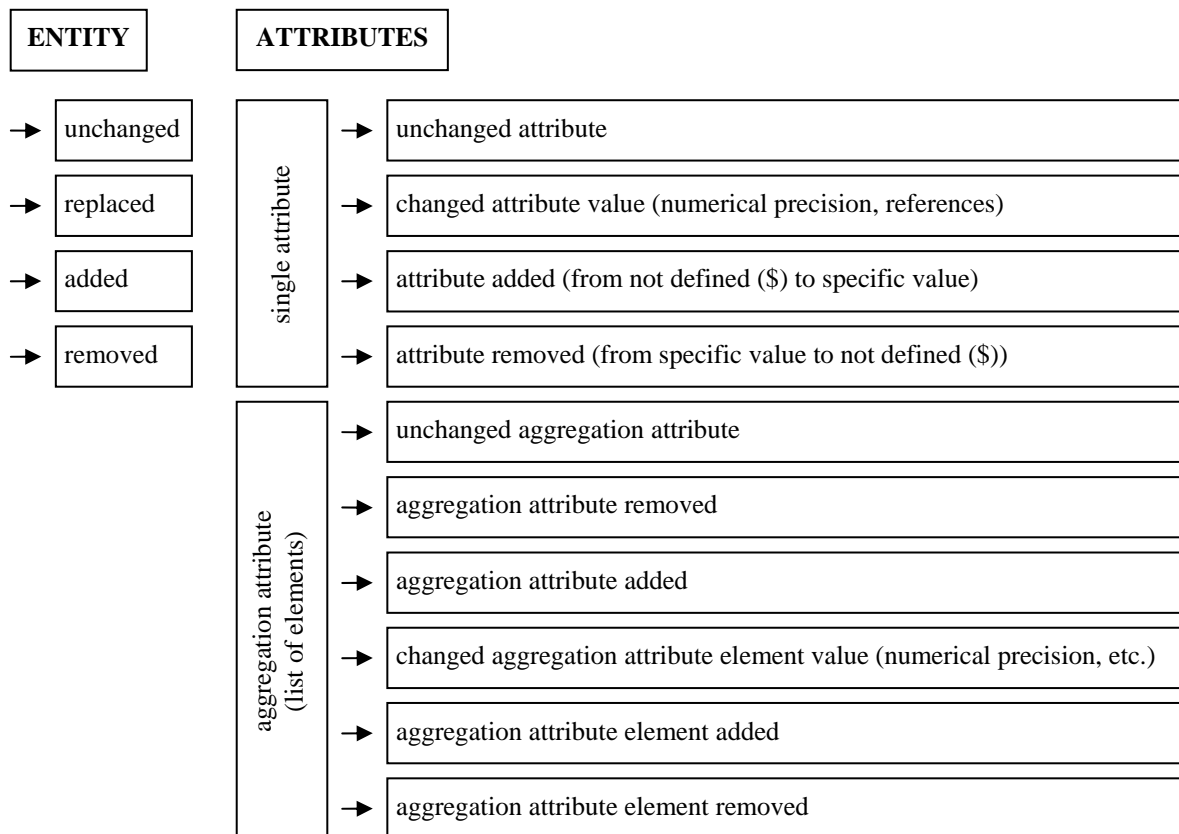

FIG.: 10 Possible differences in IFC files

After locating comparable entities (hopefully with the GUID help), the object based attribute comparison should apply. The single or aggregation attribute value can be unchanged, changed, added or removed (Fig. 10). The majority of attributes denoting reference to other entities are changed. This is expected and acceptable if the model semantic is preserved. The descriptive attributes values (e.g. Name, Description, ObjectType etc.) are also changed (or even removed) in some testing scenarios. Such information loss cannot be acceptable and consequently any reliance on the descriptive attributes within the IFC based file exchange is therefore not possible. The attributes describing the provenance data are also not preserved or corresponding attribute values are not properly assigned.

Since all additional BIM properties are interpreted according to their name attribute, the mapping of dynamically extended model is much more difficult than the mapping of the basic one. Additional properties – if defined – are eventually gathered in the GUID contained IfcPropertySet(s) and should be preserved even if they cannot be mapped into the specific application (as presented with the Archicad originated files re-exported in ADT). A possible solution presents the temporary preservation of property sets and their origin application in database and their re-inclusion in the IFC model when exporting the BIM. The database and application's native artefacts should be synchronized in order to ensure consistency of the model.

Although only the basic mapping irregularities have been presented, their magnitude in the real life IFC project can be very concerning. Regardless of the origin application and testing procedure the mapping process usually results in hundreds or thousands of differences between models. Some of them may seem unimportant and could be overlooked, but in order to fulfil the IFC model goal the majority of entities and corresponding attributes should preserve their values.

The presented IFC interface testing is not applicable only in research and development. Evaluating the differences between two supposedly equal BIMs can also be important in practical work (provenance, assuring the integrity of BIM geometry, etc). Due to the expected mapping irregularities each interface should generate a



detailed log report (like ADT interface) that contains at least information about “impossible” and “problematic” transformations within the import/export process. The presence of such reports would certainly ease the standalone analysis of mapping results.

If summarized, the mapping irregularities in practice trig interoperability. The majority of presented irregularities are interface specific and some generally reiterated regardless of the software used. They can be annotated as a standard misinterpretation or in rare cases as standard gaps. Although the perfect (semantic) interoperability will never be achieved, the transformation irregularities should be minimized – at least in the domain specific exchange. Instead of searching for transformation irregularities BIM checking should focus on other aspects – like on design errors, etc.

One of the expected issues for discussion is the final ranking of the tested IFC interfaces. This proved to be a tricky thing to do. As presented with a minor number of complex test cases all entities with clear meaning can be perfectly mapped even if different geometric artefacts are used. Regretfully, many opposite examples exist where the number of important tangible entities is lost. Before further interface evaluation difficulties in the pure round trip testing (only one application used) should be pointed out. The model inconsistencies can be observed within all tested applications and belonging interfaces – a minor number of tangible entities (IfcWall, IfcColumn, IfcSlab, IfcStair, etc) can be lost in the mapping process. Therefore even a more comprehensive list of entities can be expected when two different applications are used. Most of complex test models confirm this prediction. Even more: a group of specific entities (entity class) can be entirely eliminated within the mapping process (as presented with IfcDoor entity in Table 4). However, no specific “lost entities pattern” could be ascertain from the test results.

Due to the testing procedure used only the whole information exchange process can be evaluated. According to the test results, the ADT-ARC combination assures the most accurate mapping process. On the contrary, the use of Allplan export interface seems to generate the most inaccurate model mapping, regardless of the origin application (ARC or ADT).

One might argue why the presented study has been limited only to IFC 2x Add1 release. As emphasized in Chapter 3 the main research goal has been evaluation of hopefully mature IFC interfaces based on a stable IFC release. Similar to the other software products it is wise to use stable releases instead of the latest one, which is usually more prone to bugs and to the other implementation related inconveniences. After the IFC 2x Add1 specification had been published in 2001, the majority of certified interfaces of tested architectural design applications were available in the same or the next year. Four years of interface existence offers a period, long enough to capture the implementation feedback and include it as corrections in the later IFC interface releases. But as proved with presented research, several issues have still not been properly solved.

IFC 2x3 specification had been released in February 2006. Archicad and Allplan IFC 2x3 interface passed certification tests in April 2007 but ADT IFC 2x3 interface is still not available. Our first tests of the latest interfaces (IFC 2x3) indicate them as more thorough software products with some aspects remained to be solved. However (at least) similar research as presented should apply for credible IFC 2x3 interfaces evaluation.

Although not confirmed by tests, the mapping difficulties can be expected when exchanging the BIM geometry with other AEC-FM applications (thermal, structural analysis, etc.).

## **6. CONCLUSION**

The purpose of the IFC model is “to provide means of passing a complete, thorough and accurate building data model from computer application used by one participant to another; with no loss of information to the arranged level of precision” (AIA-NA, 2006). Unfortunately, the performed tests do not concur with this and prove the opposite: the end users practicing interoperability in day to day work still cannot blindly trust the mapping process. Although the idea of AEC-FM software interoperability may be easily understandable, the performance of IFC interfaces after almost a decade of existence and development is still not satisfying - at least it is not as accurate as end users would expect, and considering other current ICT solutions should and could expect. It seems that implementations simply do not scale up to the complex industrial use.

Anticipations like “IFC interfaces will eventually get fixed by themselves” proved to be unrealistic, too. The developers of IFC interfaces should therefore focus first on the quality improvement and secondly on implementing the model extensions.

From the end user point of view the legacy of structuralized standardization approach and insufficient commitment to the IFC specification still reflects in discovering and fixing bugs through the practical use. This cannot be justified, especially with the users constantly being pressured by sometimes impossible deadlines. In the progressively oriented sector negative feedback from practice is usually associated with frustrated end users, who will stop using the application and its interfaces, regardless of the investments they have made.

In spite of many previous recommendations for urgent improvement of geometry mapping in the IFC based BIMs, the progress is slow and hardly evident. IAI as specification developer and certification organization should improve the quality of specification (Implementation guide, Technical guide) and, furthermore, strain the certification process.

## 7. ACKNOWLEDGEMENTS

Professor Robert Amor, University of Auckland, provided invaluable assistance in the formation of presented research work. We are also grateful to our colleague Etiel Petrinja for valuable discussions about IFC model specification.

## 8. REFERENCES

- Amor R. (2006). Preservation of Meaning in Mapped IFCs, Proceedings of the fourth European Conference on Product and Process Modelling, Valencia, Spain, 13.-15. September 2006, p.233-236, Balkema.
- Backas S. (2001). SPADEX Final Report. [http://cic.vtt.fi/vera/Documents/spadex\\_final\\_report.pdf](http://cic.vtt.fi/vera/Documents/spadex_final_report.pdf).
- Bazjanac V. (2002). Early Lessons From Deployment of the IFC Compatible Software, Keynote paper, Proceedings of the fourth European Conference on Product and Process Modelling in the Building and Related Industries, Portorož, Slovenia, 9.-11. September 2002, p.9-16, Balkema.
- Behrman W. (2002). Best Practices for the Development and Use of XML Data Interchange Standards. CIFE Technical Report #131, Centre for Integrated Facility Engineering, Department of Civil and Environmental Engineering, Stanford University. <http://cife.stanford.edu/online.publications/TR#131.pdf>.
- BuildingSmart (2006). Homepage. <http://www.buildingsmart.de>.
- DDS (2006). Data Design System. <http://www.dds-bsp.co.uk/IFC.html>.
- Dayal M. (2004). Diplomarbeit: Analyse des 3D-Datenaustausches via IFC-Modell am Beispiel komplexer objektndokumentation in der Automobilindustrie mit dem Ziel der Optimierung von Planungsprozessen. Technische Universität München, Fakultät für Architektur, Lehrstuhl für Baurealisierung und Bauinformatik. <http://www.graphisoft-muenchen.de/pub/Dayal-IFC.pdf>.
- Fischer M. & Cam K. (2002). PM4D Final Report CIFE Technical report 143. Stanford University. <http://www.stanford.edu/group/4D/download/c1.html>.
- FZH (2006). Forschungszentrum Karlsruhe, Institute for Applied Computer Science, <http://www.iai.fzk.de/english/projekte/VR-Systems/html/Download/Software/index.html>.
- Geiger A. (2001). Ausführliche Testergebnisse zur IFC-Schnittstelle Version 1.5.1. Datenaustausch von einfachen Wandobjekten bis hin zu komplexen Beispielen aus dem CAD-Alltag. Forschungszentrum Karlsruhe Institut für Angewandte Informatik. <http://www.iai.fzk.de/english/projekte/VR-Systems/html/Download>.
- GEM (2006). GEM Team Solutions, [http://www.team-solutions.de/?page\\_id=19](http://www.team-solutions.de/?page_id=19).
- IAI-NA (2006). International Alliance for Interoperability, Norwegian chapter, <http://www.iai.no>.
- IAI-NO (2006). International Alliance for Interoperability, North American Chapter, <http://www.iai-na.org/technical/faqs.php>.
- IAI-MSG (2006) International Alliance for Interoperability – Model support group: Agreed procedure for two stage approach. <http://129.187.85.207/fb02/IAI-ISG-Portal/How%20to%20implement%20IFC/Certification/>.

- Kiviniemi A., Fischer M., Bazjanac V. (2005). Integration of Multiple Product Models IFC Model Servers as Potential Solution. Proceedings of the 22nd Conference on Information Technology in Construction, Dresden, Germany, 19.-21. July 2005, p. 37-40.
- Korpowski R. (2003). Diplomarbeit: Stabilität der Objektstruktur des Produktdatenmodells und des Informationsgehaltes des Planungswissens bei IFC2x. Technische Universität Dresden, Institut für Baumechanik und Bauinformatik. <http://cib.bau.tu-dresden.de/studienarbeiten/DA-Korpowski.zip>.
- Liebich T. (2004). IFC 2x Edition 2 Model Implementation Guide, Version 1.7, [http://www.iai-international.org/Model/IFC\(ifcXML\)Specs.html](http://www.iai-international.org/Model/IFC(ifcXML)Specs.html).
- Ma H., Ha E., Chung J., Amor R. (2006). Testing Semantic Interoperability. Proceedings of Joint International Conference on Computing and Decision Making in Civil and Building Engineering, Montreal, Canada, 14. - 16. June 2006, p. 1216-1225.
- Pazlar T., Turk Z. (2006). Analysis of the Geometric Data Exchange Using the IFC. Proceedings of the fourth European Conference on Product and Process Modelling, Valencia, Spain, 13.-15. September 2006, p.165-172, Balkema.
- Solibri (2006), Solibri IFC Optimizer, <http://www.solibri.fi/>
- TNO (2006). Nederlandse Organisatie voor toegenpast-natuurwetenschappelijk onderzoek, <http://www.ifcbrowser.com/>.
- Tolman F. (1999). Product modelling standards for the building and construction industry: past present and future, Automation in Construction 8 (1999), p. 227-235.
- Turk Z. (2001). Communication Revolutions, Internet and the Construction Industry, distance lecture at Purdue University, Indiana, USA, <http://www.zturk.com/db/use/works>.